

4x12x16 Ground Face, 1 Face Solid Block

Product No: 405106000

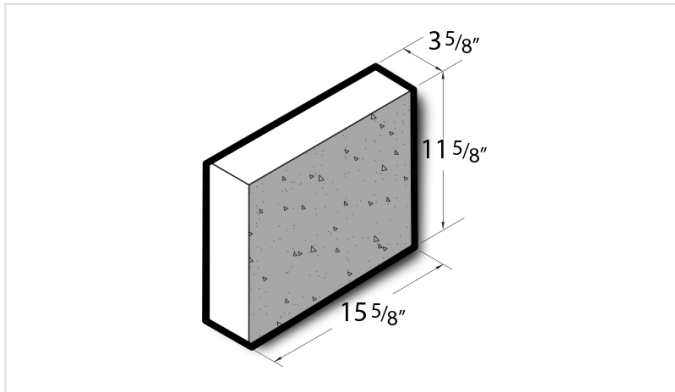

4x12x16 Ground Face, 1 Face Solid Block is a MAX Veneers Unit that delivers the natural aesthetic of stone at a cost-effective price point. All Ground Face MAX Veneers units are also available in Split Face options as well. [Contact](#) your Best Block representative for special requests and additional options.

- Available in medium, normal, and light-weight varieties
- Competitively priced and produced locally.
- Concrete blocks are naturally fire-resistant, highly durable, and its mass creates energy-efficient wall systems.
- Item weight and pallet count may vary by location.
- [Contact](#) your Best Block representative for more information.

Unit(s)

Product No.	405106000
Weight/Block:	52.5
Block/Pallet:	60
Pallet Weight:	3210