

8x8x16 4 Rib Split

Product No: 803097100

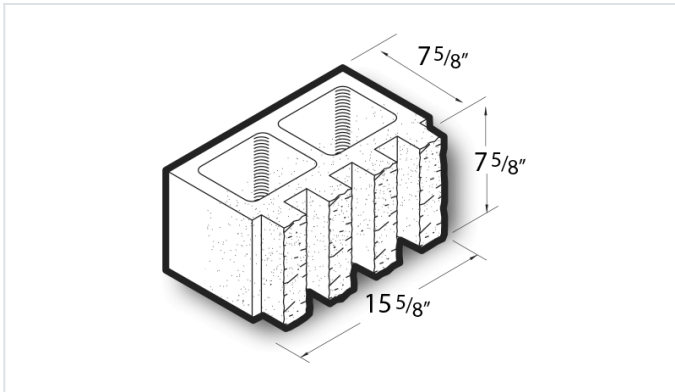

8x8x16 4 Rib Split or Ribbed block includes vertical scores and come in a wide variety of styles and sizes that exceed ASTM C90 standard specifications in all weight classifications. [Contact](#) your Best Block representative for special requests and additional options.

- Available in medium, normal, and light-weight varieties
- Competitively priced and produced locally.
- Concrete blocks are naturally fire-resistant, highly durable, and its mass creates energy-efficient wall systems.
- Item weight and pallet count may vary by location.
- [Contact](#) your Best Block representative for more information.

Unit(s)

Product No.	803097100
Weight/Block:	32
Block/Pallet:	72
Pallet Weight:	2364