

8x8x16 Single Bullnose Block

Product No: 801005100

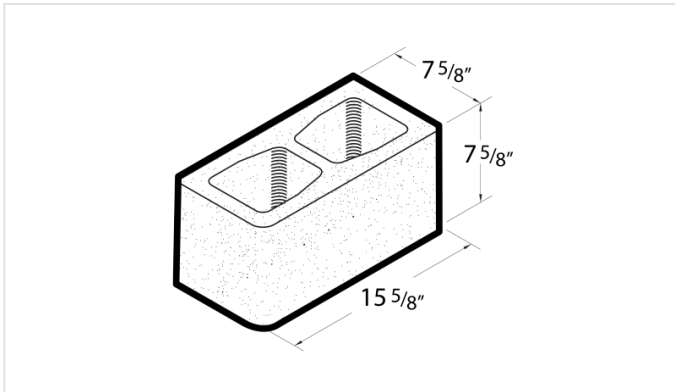

8x8x16 Single Bullnose Block is a standard concrete masonry unit (CMU) that exceeds ASTM C90 standard specifications in all weight classifications.

Contact your Best Block representative for special requests and additional options.

- Available in medium, normal, and light-weight varieties
- Competitively priced and produced locally.
- Concrete blocks are naturally fire-resistant, highly durable, and its mass creates energy-efficient wall systems.
- Item weight and pallet count may vary by location.
- **Contact** your Best Block representative for more information.

Unit(s)

Product No.	801005100
Weight/Block:	35
Block/Pallet:	72
Pallet Weight:	2520