

**12x8x12 Single Core Pilaster Block**

**Product No: 121025100**

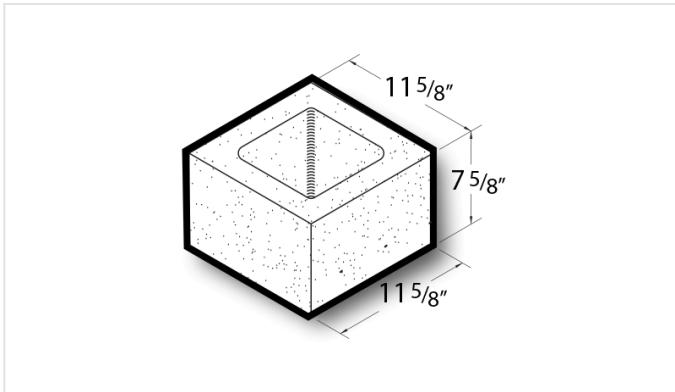

12x8x12 Single Core Pilaster Block is a standard concrete masonry unit (CMU) that exceeds ASTM C90 standard specifications in all weight classifications. [Contact](#) your Best Block representative for special requests and additional options.

- Available in medium, normal, and light-weight varieties
- Competitively priced and produced locally.
- Concrete blocks are naturally fire-resistant, highly durable, and its mass creates energy-efficient wall systems.
- Item weight and pallet count may vary by location.
- [Contact](#) your Best Block representative for more information.

**Unit(s)**

<b>Product No.</b>	121025100
<b>Weight/Block:</b>	36
<b>Block/Pallet:</b>	72
<b>Pallet Weight:</b>	2652